

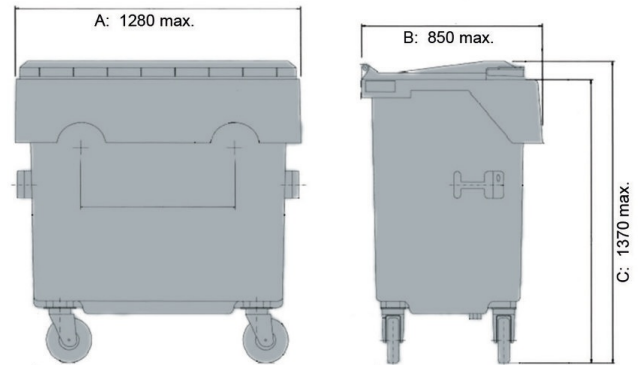

DU Container 660 l - 1,1 m³ 770 l



Technical data			
External Dimensions L x W x H (mm)	A: 1280 max.	B: 850 max.	C: 1370 max.
Volume (l)	770 l		
Material Body / Material Lid	PE / PE		
Holding Capacity (kg)	 308 kg		
Available colours	grey, green, brown, blue, yellow, red		
Characteristics		Extra equipment / Accessories	
Travelling gear:	Wheel Ø 200 mm, rubber-tired wheels, 4 guide rollers, 2 wheel stops or central locking system	Glas slot Paper slot	
Receiver:	Diamond receiver	Central locking system	
Prepared for transponder:	Yes	Lifting grips DIN-trunnion Foot-operated lid opener Fork-lift pockets Oil-sealed welding (sheet metal)	
Loading quantities (Pcs / Approximate amount)			
On request			
Labelling			
On the lid, on the body			

*1 All specifications quoted are subject to change. Craemer reserve the right to make changes to product design and specification.

*2 Extra equipment, accessories, as well as other colors are available at extra cost and on request.